

3P4-BL50x18-22

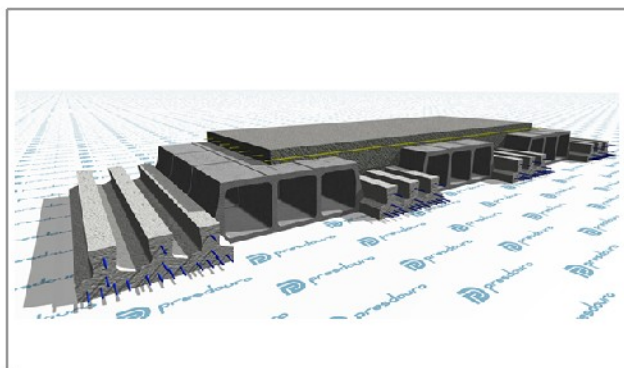

Dados Genéricos

Tipo de Abobadilha :	BL50x18
Tipo de Vigota :	P4
Peso :	3.12 (kN/m ²)
Altura :	220 (mm)

Elementos para Cálculo

Dados Geométricos

Altura :	220 (mm)
Acima Bloco :	40 (mm)
Entre Vigotas :	830 (mm)
Peso Próprio :	3.12 (kN/m ²)

Dados Mecânicos

MRd :	63.4 (kN.m/m)
VRd :	46.9 (kN/m)
Mfctk :	36.7 (kN.m/m)
EI :	16134 (kN.m ² /m)

Q. Materiais

Distr. A500 :	172 (mm ² /m)
Vigotas :	3.61 (m/m ²)
Bloco :	4.82 (Un/m ²)
Betão :	83.5 (Litros/m ²)

Compostos do Pavimento

P4

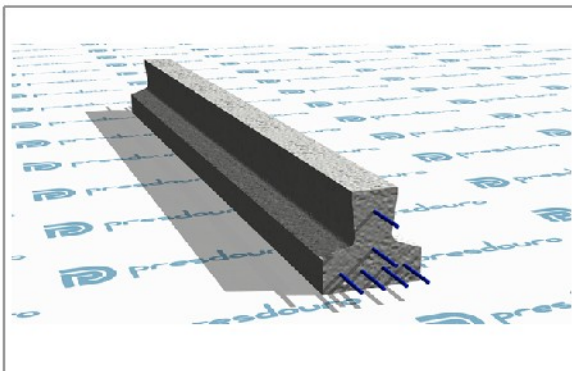

BL50x18

