

## 3P2-BL50x18-23

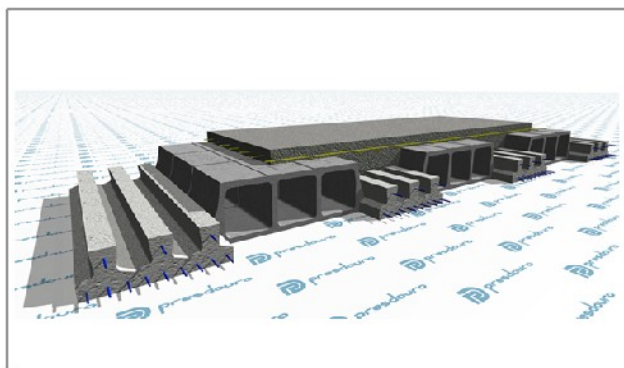

### Dados Genéricos

Tipo de Abobadilha :	BL50x18
Tipo de Vigota :	P2
Peso :	3.35 (kN/m <sup>2</sup> )
Altura :	230 (mm)

## Elementos para Cálculo

### Dados Geométricos

Altura :	230 (mm)
Acima Bloco :	50 (mm)
Entre Vigotas :	830 (mm)
Peso Próprio :	3.35 (kN/m <sup>2</sup> )

### Dados Mecânicos

MRd :	45.7 (kN.m/m)
VRd :	49.3 (kN/m)
Mfctk :	28.8 (kN.m/m)
EI :	18598 (kN.m <sup>2</sup> /m)

### Q. Materiais

Distr. A500 :	115 (mm <sup>2</sup> /m)
Vigotas :	3.61 (m/m <sup>2</sup> )
Bloco :	4.82 (Un/m <sup>2</sup> )
Betão :	93.5 (Litros/m <sup>2</sup> )

## Compostos do Pavimento

### P2

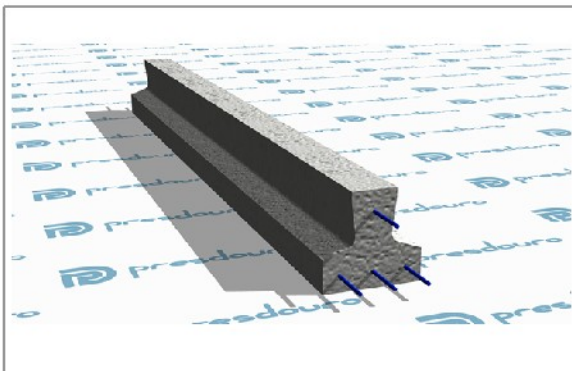

### BL50x18

