

3P2-BL50x18-22

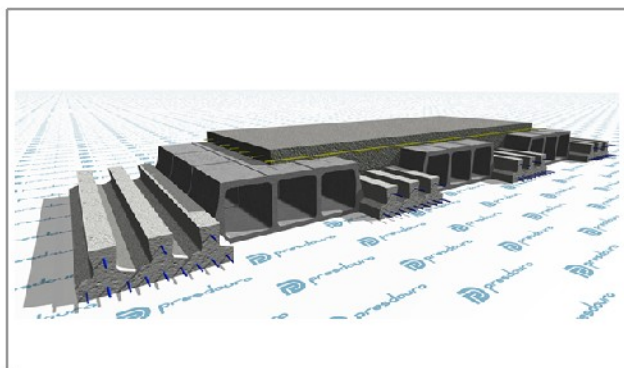

Dados Genéricos

Tipo de Abobadilha :	BL50x18
Tipo de Vigota :	P2
Peso :	3.11 (kN/m ²)
Altura :	220 (mm)

Elementos para Cálculo

Dados Geométricos

Altura :	220 (mm)
Acima Bloco :	40 (mm)
Entre Vigotas :	830 (mm)
Peso Próprio :	3.11 (kN/m ²)

Dados Mecânicos

MRd :	43.2 (kN.m/m)
VRd :	46.9 (kN/m)
Mfctk :	26.8 (kN.m/m)
EI :	15993 (kN.m ² /m)

Q. Materiais

Distr. A500 :	115 (mm ² /m)
Vigotas :	3.61 (m/m ²)
Bloco :	4.82 (Un/m ²)
Betão :	83.5 (Litros/m ²)

Compostos do Pavimento

P2

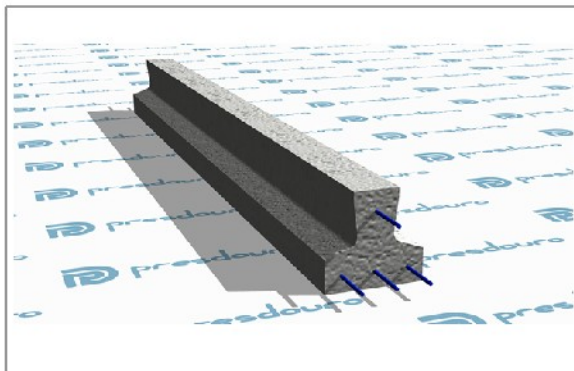

BL50x18

