

3P2-BL50x18-21

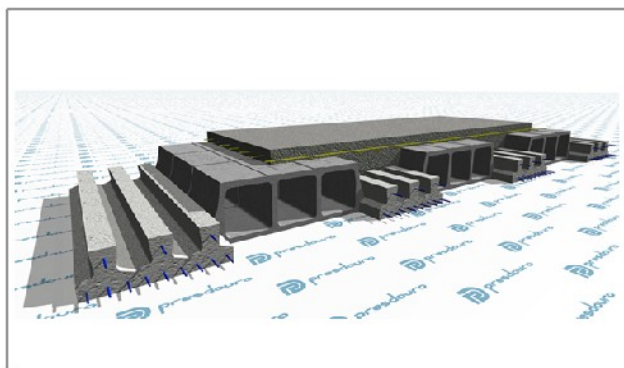

Dados Genéricos

Tipo de Abobadilha :	BL50x18
Tipo de Vigota :	P2
Peso :	2.87 (kN/m ²)
Altura :	210 (mm)

Elementos para Cálculo

Dados Geométricos

Altura :	210 (mm)
Acima Bloco :	30 (mm)
Entre Vigotas :	830 (mm)
Peso Próprio :	2.87 (kN/m ²)

Dados Mecânicos

MRd :	40.7 (kN.m/m)
VRd :	44.6 (kN/m)
Mfctk :	24.7 (kN.m/m)
EI :	13494 (kN.m ² /m)

Q. Materiais

Distr. A500 :	115 (mm ² /m)
Vigotas :	3.61 (m/m ²)
Bloco :	4.82 (Un/m ²)
Betão :	73.5 (Litros/m ²)

Compostos do Pavimento

P2

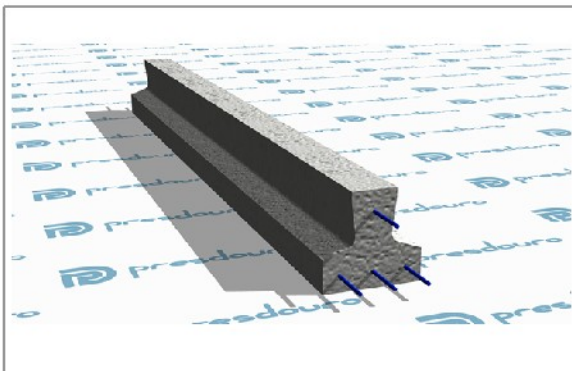

BL50x18

