

## 2P4-BL50x18-22

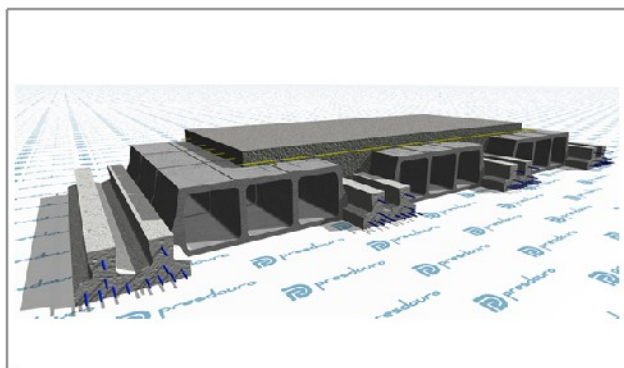

### Dados Genéricos

Tipo de Abobadilha :	BL50x18
Tipo de Vigota :	P4
Peso :	2.77 (kN/m <sup>2</sup> )
Altura :	220 (mm)

## Elementos para Cálculo

### Dados Geométricos

Altura :	220 (mm)
Acima Bloco :	40 (mm)
Entre Vigotas :	720 (mm)
Peso Próprio :	2.77 (kN/m <sup>2</sup> )

### Dados Mecânicos

MRd :	49.7 (kN.m/m)
VRd :	35.6 (kN/m)
Mfctk :	29.2 (kN.m/m)
EI :	13660 (kN.m <sup>2</sup> /m)

### Q. Materiais

Distr. A500 :	132 (mm <sup>2</sup> /m)
Vigotas :	2.78 (m/m <sup>2</sup> )
Bloco :	5.56 (Un/m <sup>2</sup> )
Betão :	73.0 (Litros/m <sup>2</sup> )

## Compostos do Pavimento

### P4

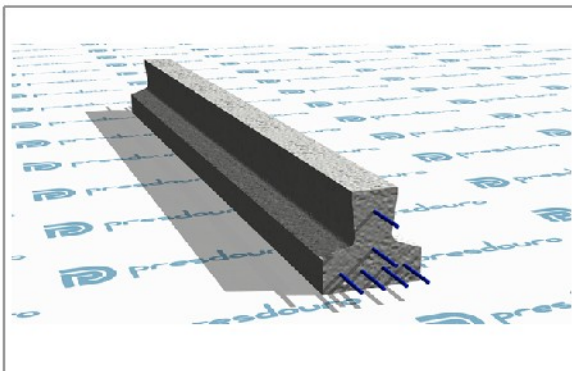

### BL50x18

