

2P4-BL50x18-21

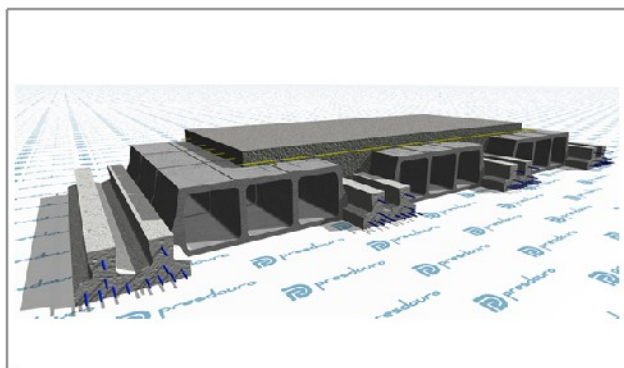

Dados Genéricos

Tipo de Abobadilha :	BL50x18
Tipo de Vigota :	P4
Peso :	2.53 (kN/m ²)
Altura :	210 (mm)

Elementos para Cálculo

Dados Geométricos

Altura :	210 (mm)
Acima Bloco :	30 (mm)
Entre Vigotas :	720 (mm)
Peso Próprio :	2.53 (kN/m ²)

Dados Mecânicos

MRd :	46.9 (kN.m/m)
VRd :	33.8 (kN/m)
Mfctk :	27.0 (kN.m/m)
EI :	11511 (kN.m ² /m)

Q. Materiais

Distr. A500 :	132 (mm ² /m)
Vigotas :	2.78 (m/m ²)
Bloco :	5.56 (Un/m ²)
Betão :	63.0 (Litros/m ²)

Compostos do Pavimento

P4

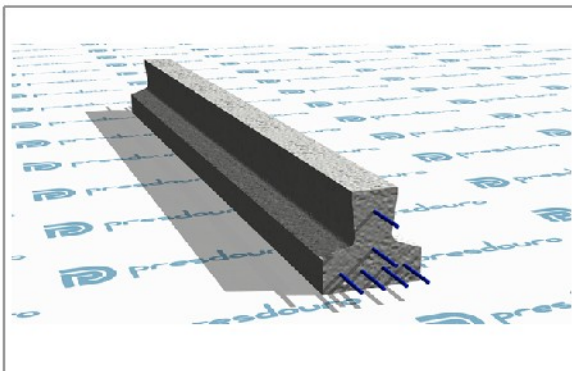

BL50x18

