

2P4-BL23x21-26

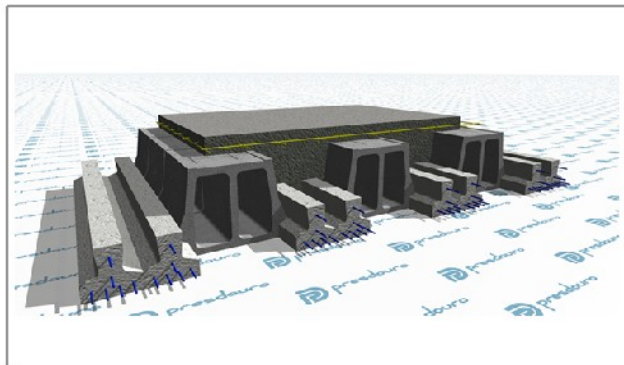

Dados Genéricos

Tipo de Abobadilha :	BL23x21
Tipo de Vigota :	P4
Peso :	4.21 (kN/m ²)
Altura :	260 (mm)

Elementos para Cálculo

Dados Geométricos

Altura :	260 (mm)
Acima Bloco :	50 (mm)
Entre Vigotas :	450 (mm)
Peso Próprio :	4.21 (kN/m ²)

Dados Mecânicos

MRd :	94.6 (kN.m/m)
VRd :	68.3 (kN/m)
Mfctk :	57.2 (kN.m/m)
EI :	29845 (kN.m ² /m)

Q. Materiais

Distr. A500 :	212 (mm ² /m)
Vigotas :	4.44 (m/m ²)
Bloco :	8.89 (Un/m ²)
Betão :	118.7 (Litros/m ²)

Compostos do Pavimento

P4

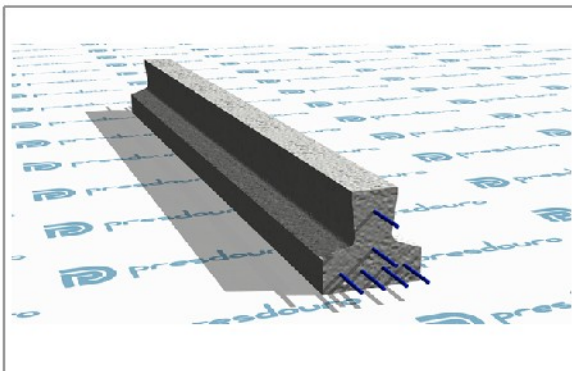

BL23x21

