

2P4-BL23x21-25

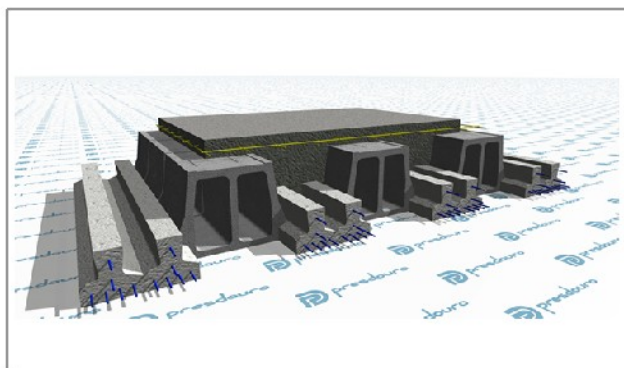

Dados Genéricos

Tipo de Abobadilha :	BL23x21
Tipo de Vigota :	P4
Peso :	3.97 (kN/m ²)
Altura :	250 (mm)

Elementos para Cálculo

Dados Geométricos

Altura :	250 (mm)
Acima Bloco :	40 (mm)
Entre Vigotas :	450 (mm)
Peso Próprio :	3.97 (kN/m ²)

Dados Mecânicos

MRd :	90.1 (kN.m/m)
VRd :	65.4 (kN/m)
Mfctk :	53.7 (kN.m/m)
EI :	26087 (kN.m ² /m)

Q. Materiais

Distr. A500 :	212 (mm ² /m)
Vigotas :	4.44 (m/m ²)
Bloco :	8.89 (Un/m ²)
Betão :	108.7 (Litros/m ²)

Compostos do Pavimento

P4

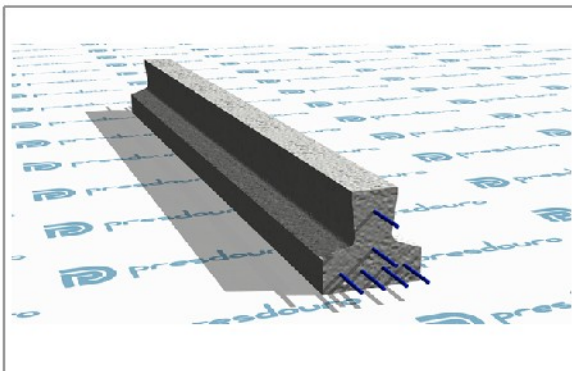

BL23x21

