

2P1-BL50x18-23

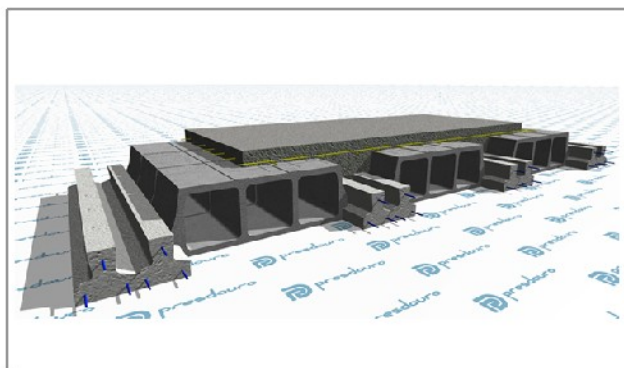

Dados Genéricos

Tipo de Abobadilha :	BL50x18
Tipo de Vigota :	P1
Peso :	2.99 (kN/m ²)
Altura :	230 (mm)

Elementos para Cálculo

Dados Geométricos

Altura :	230 (mm)
Acima Bloco :	50 (mm)
Entre Vigotas :	720 (mm)
Peso Próprio :	2.99 (kN/m ²)

Dados Mecânicos

MRd :	26.1 (kN.m/m)
VRd :	37.3 (kN/m)
Mfctk :	16.0 (kN.m/m)
EI :	15634 (kN.m ² /m)

Q. Materiais

Distr. A500 :	66 (mm ² /m)
Vigotas :	2.78 (m/m ²)
Bloco :	5.56 (Un/m ²)
Betão :	83.0 (Litros/m ²)

Compostos do Pavimento

P1

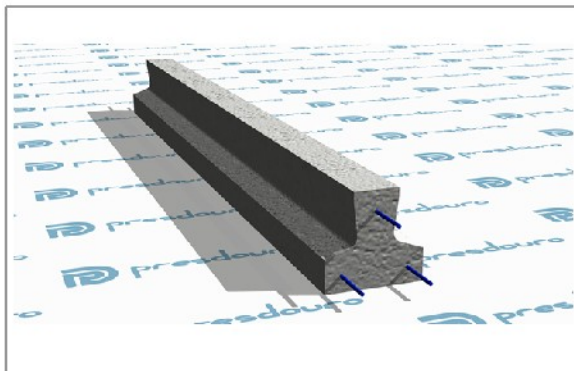

BL50x18

