

2P1-BL50x18-22

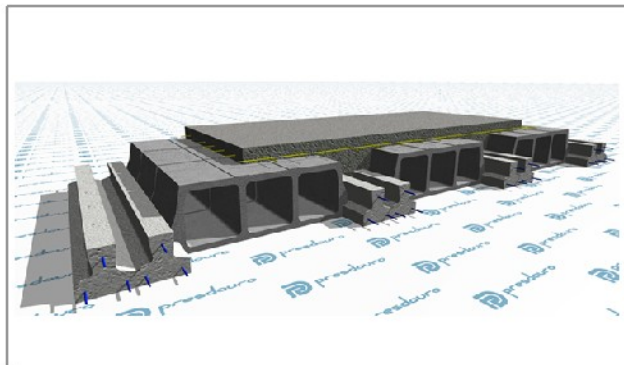

Dados Genéricos

| | |
|----------------------|---------------------------|
| Tipo de Abobadilha : | BL50x18 |
| Tipo de Vigota : | P1 |
| Peso : | 2.75 (kN/m ²) |
| Altura : | 220 (mm) |

Elementos para Cálculo

Dados Geométricos

| | |
|-----------------|---------------------------|
| Altura : | 220 (mm) |
| Acima Bloco : | 40 (mm) |
| Entre Vigotas : | 720 (mm) |
| Peso Próprio : | 2.75 (kN/m ²) |

Dados Mecânicos

| | |
|---------|------------------------------|
| MRd : | 24.7 (kN.m/m) |
| VRd : | 35.6 (kN/m) |
| Mfctk : | 14.9 (kN.m/m) |
| EI : | 13457 (kN.m ² /m) |

Q. Materiais

| | |
|---------------|-------------------------------|
| Distr. A500 : | 66 (mm ² /m) |
| Vigotas : | 2.78 (m/m ²) |
| Bloco : | 5.56 (Un/m ²) |
| Betão : | 73.0 (Litros/m ²) |

Compostos do Pavimento

P1

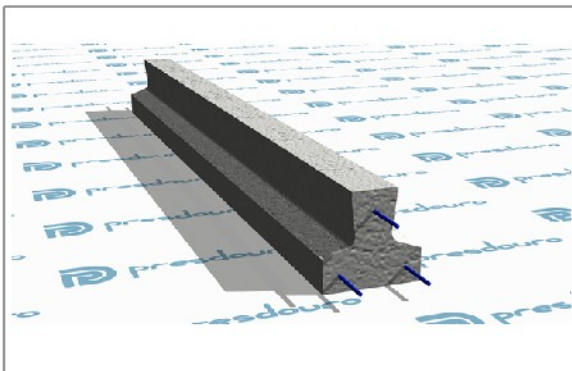

BL50x18

