

## 2P1-BL23x21-26

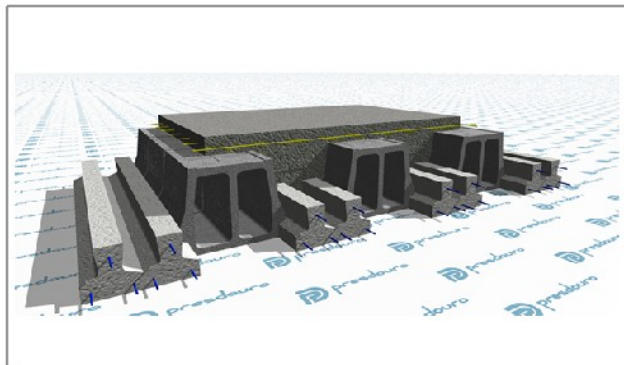

### Dados Genéricos

Tipo de Abobadilha :	BL23x21
Tipo de Vigota :	P1
Peso :	4.17 (kN/m <sup>2</sup> )
Altura :	260 (mm)

## Elementos para Cálculo

### Dados Geométricos

Altura :	260 (mm)
Acima Bloco :	50 (mm)
Entre Vigotas :	450 (mm)
Peso Próprio :	4.17 (kN/m <sup>2</sup> )

### Dados Mecânicos

MRd :	47.9 (kN.m/m)
VRd :	68.3 (kN/m)
Mfctk :	29.3 (kN.m/m)
EI :	29448 (kN.m <sup>2</sup> /m)

### Q. Materiais

Distr. A500 :	106 (mm <sup>2</sup> /m)
Vigotas :	4.44 (m/m <sup>2</sup> )
Bloco :	8.89 (Un/m <sup>2</sup> )
Betão :	118.7 (Litros/m <sup>2</sup> )

## Compostos do Pavimento

### P1

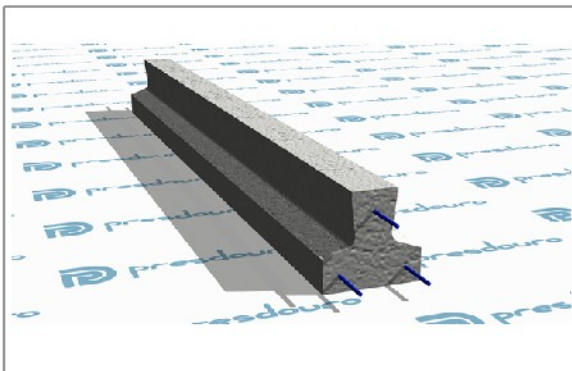

### BL23x21

