

P4-BL40x21-25

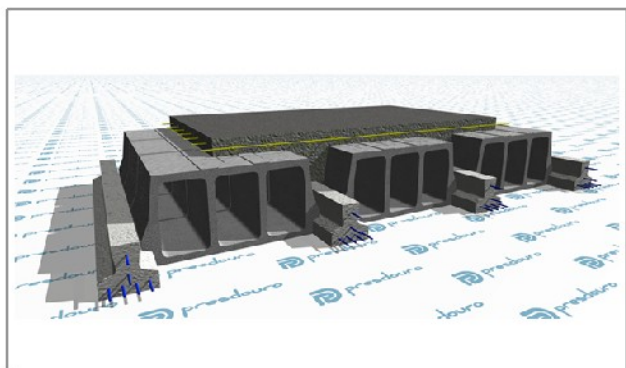

Dados Genéricos

Tipo de Abobadilha :	BL40x21
Tipo de Vigota :	P4
Peso :	2.82 (kN/m ²)
Altura :	250 (mm)

Elementos para Cálculo

Dados Geométricos

Altura :	250 (mm)
Acima Bloco :	40 (mm)
Entre Vigotas :	510 (mm)
Peso Próprio :	2.82 (kN/m ²)

Dados Mecânicos

MRd :	41.8 (kN.m/m)
VRd :	26.0 (kN/m)
Mfctk :	26.0 (kN.m/m)
EI :	15260 (kN.m ² /m)

Q. Materiais

Distr. A500 :	93 (mm ² /m)
Vigotas :	1.96 (m/m ²)
Bloco :	7.84 (Un/m ²)
Betão :	69.8 (Litros/m ²)

Compostos do Pavimento

P4

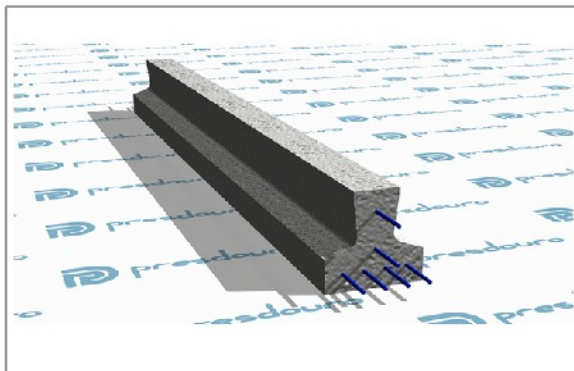

BL40x21

