

## P4-BL33x30-33

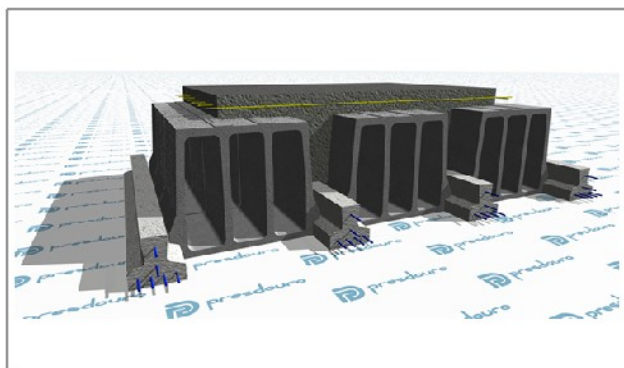

### Dados Genéricos

Tipo de Abobadilha :	BL33x30
Tipo de Vigota :	P4
Peso :	3.46 (kN/m <sup>2</sup> )
Altura :	330 (mm)

## Elementos para Cálculo

### Dados Geométricos

Altura :	330 (mm)
Acima Bloco :	30 (mm)
Entre Vigotas :	440 (mm)
Peso Próprio :	3.46 (kN/m <sup>2</sup> )

### Dados Mecânicos

MRd :	66.9 (kN.m/m)
VRd :	40.6 (kN/m)
Mfctk :	44.2 (kN.m/m)
EI :	34728 (kN.m <sup>2</sup> /m)

### Q. Materiais

Distr. A500 :	108 (mm <sup>2</sup> /m)
Vigotas :	2.27 (m/m <sup>2</sup> )
Bloco :	9.09 (Un/m <sup>2</sup> )
Betão :	90.3 (Litros/m <sup>2</sup> )

## Compostos do Pavimento

### P4

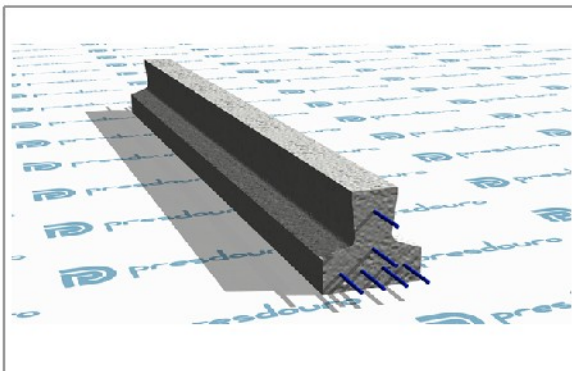

### BL33x30

