

P4-BL23x21-26

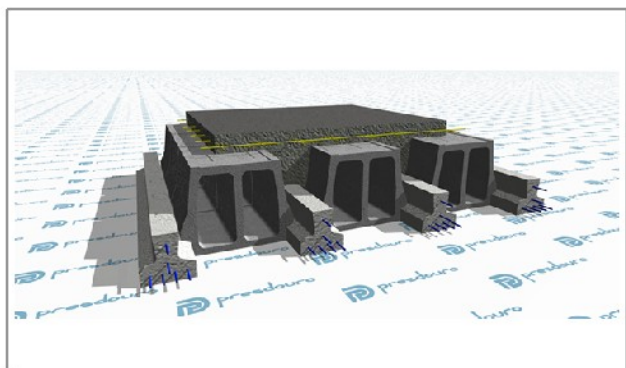

Dados Genéricos

Tipo de Abobadilha :	BL23x21
Tipo de Vigota :	P4
Peso :	3.51 (kN/m ²)
Altura :	260 (mm)

Elementos para Cálculo

Dados Geométricos

Altura :	260 (mm)
Acima Bloco :	50 (mm)
Entre Vigotas :	340 (mm)
Peso Próprio :	3.51 (kN/m ²)

Dados Mecânicos

MRd :	64.5 (kN.m/m)
VRd :	40.7 (kN/m)
Mfctk :	39.8 (kN.m/m)
EI :	22635 (kN.m ² /m)

Q. Materiais

Distr. A500 :	140 (mm ² /m)
Vigotas :	2.94 (m/m ²)
Bloco :	11.76 (Un/m ²)
Betão :	94.9 (Litros/m ²)

Compostos do Pavimento

P4

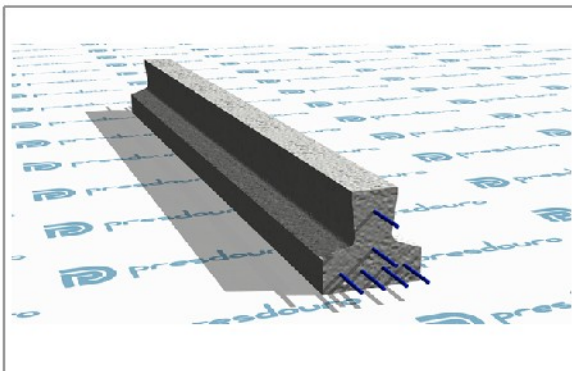

BL23x21

