

P4-BL23x21-24

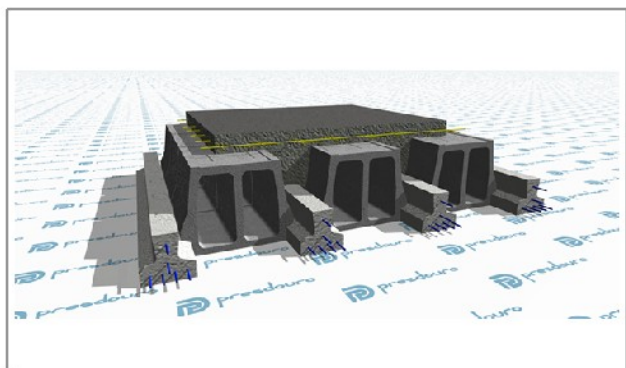

Dados Genéricos

Tipo de Abobadilha :	BL23x21
Tipo de Vigota :	P4
Peso :	3.03 (kN/m ²)
Altura :	240 (mm)

Elementos para Cálculo

Dados Geométricos

Altura :	240 (mm)
Acima Bloco :	30 (mm)
Entre Vigotas :	340 (mm)
Peso Próprio :	3.03 (kN/m ²)

Dados Mecânicos

MRd :	58.6 (kN.m/m)
VRd :	37.3 (kN/m)
Mfctk :	35.0 (kN.m/m)
EI :	16943 (kN.m ² /m)

Q. Materiais

Distr. A500 :	140 (mm ² /m)
Vigotas :	2.94 (m/m ²)
Bloco :	11.76 (Un/m ²)
Betão :	74.9 (Litros/m ²)

Compostos do Pavimento

P4

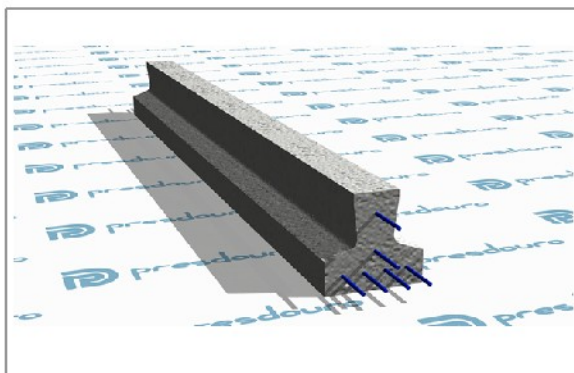

BL23x21

