

P2-BL40x21-24

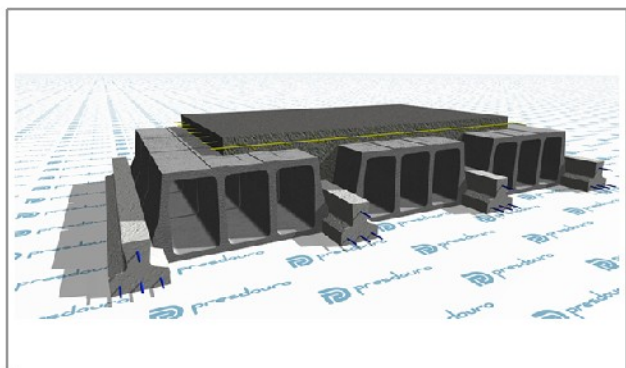

Dados Genéricos

Tipo de Abobadilha :	BL40x21
Tipo de Vigota :	P2
Peso :	2.57 (kN/m ²)
Altura :	240 (mm)

Elementos para Cálculo

Dados Geométricos

Altura :	240 (mm)
Acima Bloco :	30 (mm)
Entre Vigotas :	510 (mm)
Peso Próprio :	2.57 (kN/m ²)

Dados Mecânicos

MRd :	26.7 (kN.m/m)
VRd :	24.9 (kN/m)
Mfctk :	17.8 (kN.m/m)
EI :	12928 (kN.m ² /m)

Q. Materiais

Distr. A500 :	62 (mm ² /m)
Vigotas :	1.96 (m/m ²)
Bloco :	7.84 (Un/m ²)
Betão :	59.8 (Litros/m ²)

Compostos do Pavimento

P2

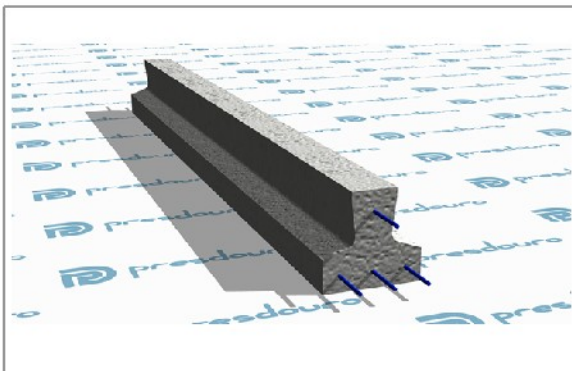

BL40x21

