

P2-BL33x30-34

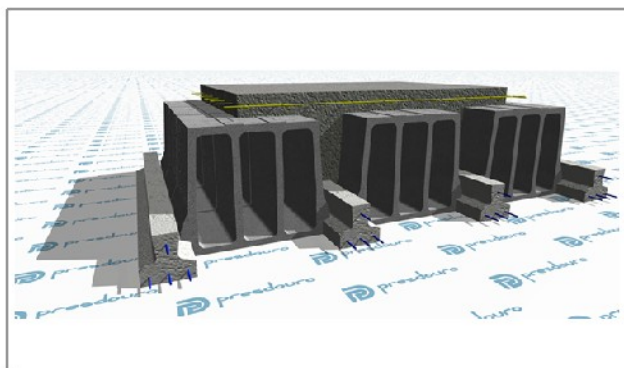

Dados Genéricos

Tipo de Abobadilha :	BL33x30
Tipo de Vigota :	P2
Peso :	3.69 (kN/m ²)
Altura :	340 (mm)

Elementos para Cálculo

Dados Geométricos

Altura :	340 (mm)
Acima Bloco :	40 (mm)
Entre Vigotas :	440 (mm)
Peso Próprio :	3.69 (kN/m ²)

Dados Mecânicos

MRd :	46.4 (kN.m/m)
VRd :	41.9 (kN/m)
Mfctk :	33.8 (kN.m/m)
EI :	39397 (kN.m ² /m)

Q. Materiais

Distr. A500 :	72 (mm ² /m)
Vigotas :	2.27 (m/m ²)
Bloco :	9.09 (Un/m ²)
Betão :	100.3 (Litros/m ²)

Compostos do Pavimento

P2

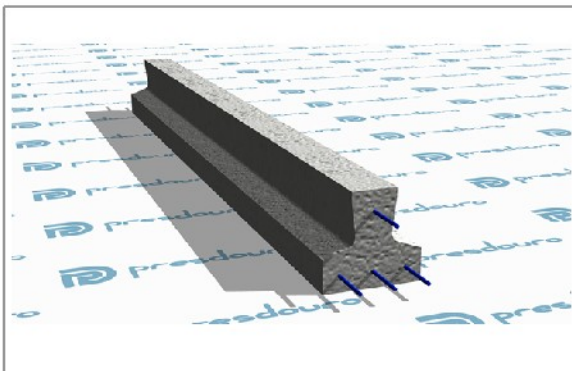

BL33x30

