

## P1-BL40x21-26

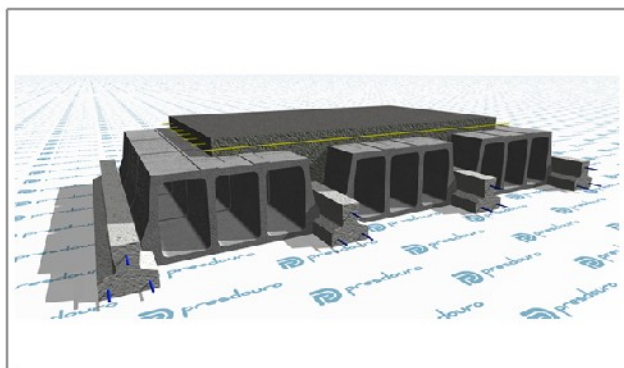

### Dados Genéricos

Tipo de Abobadilha :	BL40x21
Tipo de Vigota :	P1
Peso :	3.04 (kN/m <sup>2</sup> )
Altura :	260 (mm)

## Elementos para Cálculo

### Dados Geométricos

Altura :	260 (mm)
Acima Bloco :	50 (mm)
Entre Vigotas :	510 (mm)
Peso Próprio :	3.04 (kN/m <sup>2</sup> )

### Dados Mecânicos

MRd :	21.6 (kN.m/m)
VRd :	27.1 (kN/m)
Mfctk :	14.1 (kN.m/m)
EI :	17205 (kN.m <sup>2</sup> /m)

### Q. Materiais

Distr. A500 :	47 (mm <sup>2</sup> /m)
Vigotas :	1.96 (m/m <sup>2</sup> )
Bloco :	7.84 (Un/m <sup>2</sup> )
Betão :	79.8 (Litros/m <sup>2</sup> )

## Compostos do Pavimento

### P1

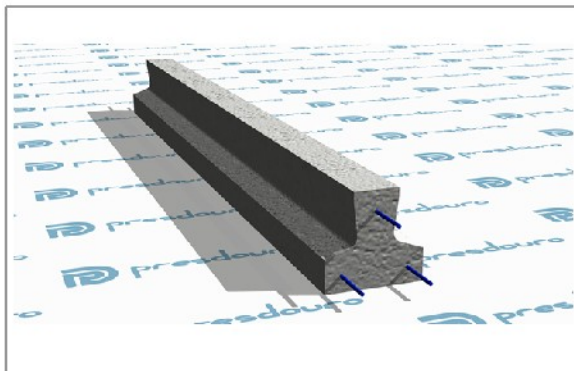

### BL40x21

