

P1-BL33x30-35

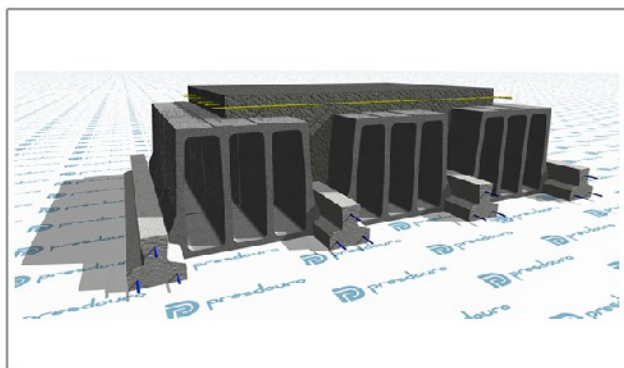

Dados Genéricos

| | |
|----------------------|---------------------------|
| Tipo de Abobadilha : | BL33x30 |
| Tipo de Vigota : | P1 |
| Peso : | 3.93 (kN/m ²) |
| Altura : | 350 (mm) |

Elementos para Cálculo

Dados Geométricos

| | |
|-----------------|---------------------------|
| Altura : | 350 (mm) |
| Acima Bloco : | 50 (mm) |
| Entre Vigotas : | 440 (mm) |
| Peso Próprio : | 3.93 (kN/m ²) |

Dados Mecânicos

| | |
|---------|------------------------------|
| MRd : | 35.6 (kN.m/m) |
| VRd : | 43.3 (kN/m) |
| Mfctk : | 24.7 (kN.m/m) |
| EI : | 44085 (kN.m ² /m) |

Q. Materiais

| | |
|---------------|--------------------------------|
| Distr. A500 : | 54 (mm ² /m) |
| Vigotas : | 2.27 (m/m ²) |
| Bloco : | 9.09 (Un/m ²) |
| Betão : | 110.3 (Litros/m ²) |

Compostos do Pavimento

P1

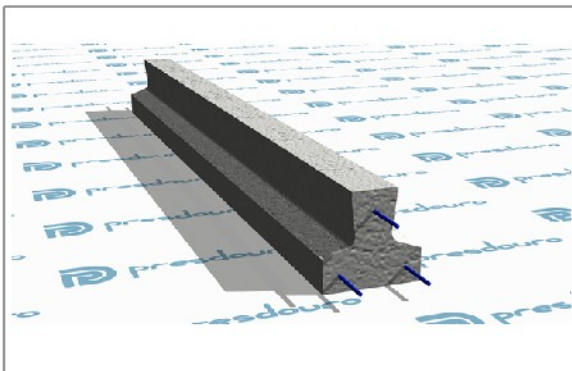

BL33x30

