

## P1-BL33x30-33

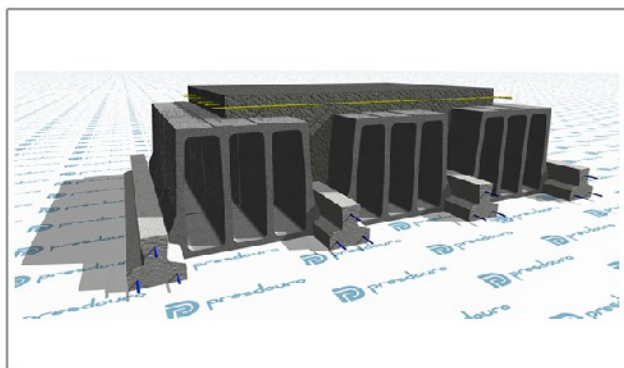

### Dados Genéricos

Tipo de Abobadilha :	BL33x30
Tipo de Vigota :	P1
Peso :	3.45 (kN/m <sup>2</sup> )
Altura :	330 (mm)

## Elementos para Cálculo

### Dados Geométricos

Altura :	330 (mm)
Acima Bloco :	30 (mm)
Entre Vigotas :	440 (mm)
Peso Próprio :	3.45 (kN/m <sup>2</sup> )

### Dados Mecânicos

MRd :	33.2 (kN.m/m)
VRd :	40.6 (kN/m)
Mfctk :	22.6 (kN.m/m)
EI :	34300 (kN.m <sup>2</sup> /m)

### Q. Materiais

Distr. A500 :	54 (mm <sup>2</sup> /m)
Vigotas :	2.27 (m/m <sup>2</sup> )
Bloco :	9.09 (Un/m <sup>2</sup> )
Betão :	90.3 (Litros/m <sup>2</sup> )

## Compostos do Pavimento

P1

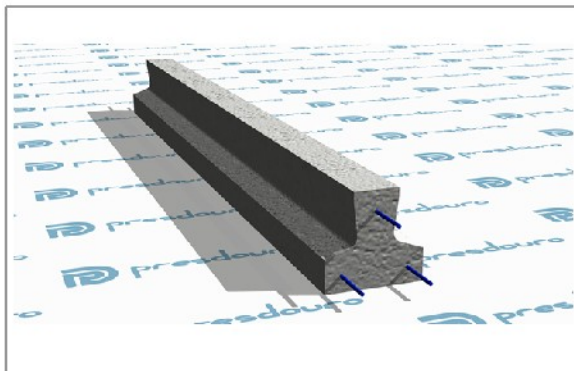

BL33x30

