

P1-BL23x21-25

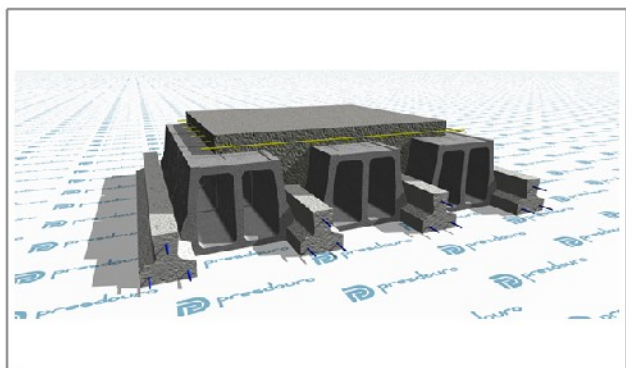

Dados Genéricos

Tipo de Abobadilha :	BL23x21
Tipo de Vigota :	P1
Peso :	3.24 (kN/m ²)
Altura :	250 (mm)

Elementos para Cálculo

Dados Geométricos

Altura :	250 (mm)
Acima Bloco :	40 (mm)
Entre Vigotas :	340 (mm)
Peso Próprio :	3.24 (kN/m ²)

Dados Mecânicos

MRd :	30.6 (kN.m/m)
VRd :	39.0 (kN/m)
Mfctk :	19.1 (kN.m/m)
EI :	19464 (kN.m ² /m)

Q. Materiais

Distr. A500 :	70 (mm ² /m)
Vigotas :	2.94 (m/m ²)
Bloco :	11.76 (Un/m ²)
Betão :	84.9 (Litros/m ²)

Compostos do Pavimento

P1

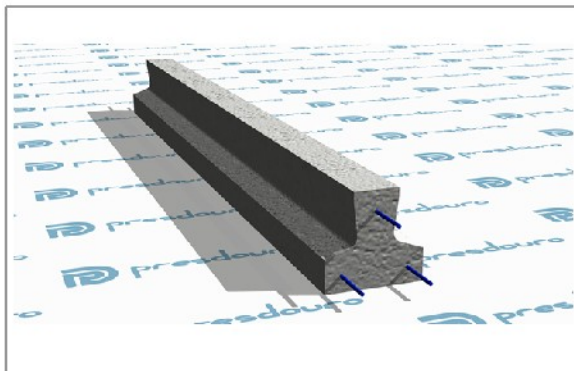

BL23x21

